

# PRODUCT INFORMATION

08-2024

# GRIP

## SLEEPING

---

Kettner

**WARDROBE WITH SLIDING DOORS 2-PART**

carcase modules  
 W: 40 / 50 / 60 / 70 / 80 / 100 / 120  
 H: 195 / 214 / 233 / 243 / 253 / 272  
 total depth incl. front: 66.2 / 70.1  
 Effective depth: Shelf 54.0 / Clothes bar 61.4

Possible cabinet widths  
 W: 160 / 180 / 200 / 240 / 280 / 300 / 320 / 360 / 400  
 Dimensions in cm

**EXAMPLE COMPOSITION TOTAL WIDTH 320 CM - 2 SLIDING DOORS**

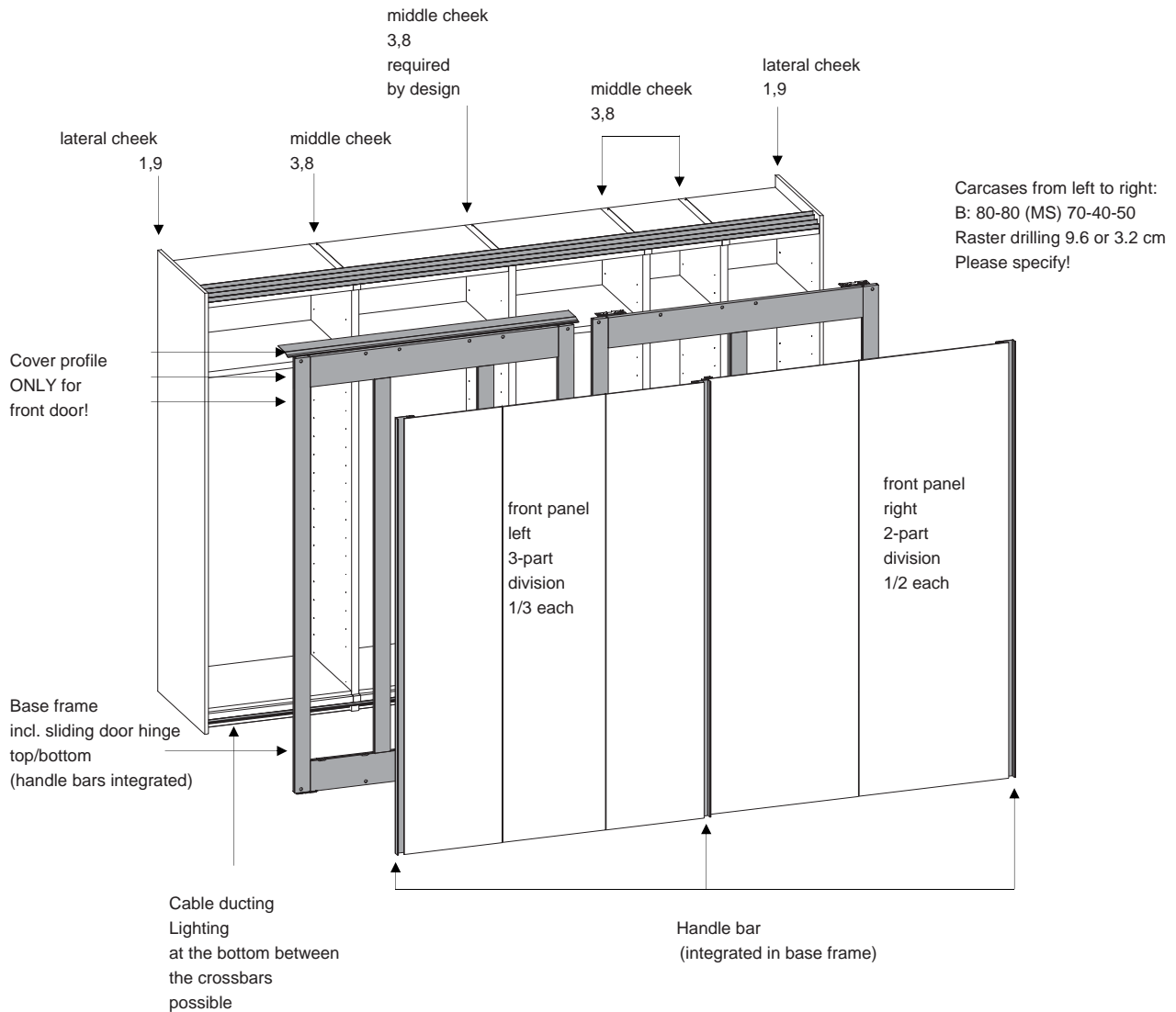

**BASE FRAME 2 rails TOP VIEW - WITH 2 SLIDING ELEMENTS**



**PLANNING INFORMATION:**

- required height for installation +4.0 cm
- required width for installation: +4.0 cm
- lining left/right possible; not possible at top!
- Wall mounting (anti-tilt) backside left and right through rear wall required. Fitting included.
- room divider not possible!
- Shortening in T/H possible! See special requests.

<b>WARDROBE WITH SLIDING DOORS 3-PART</b>	
carcase modules W: 40 / 50 / 60 / 70 / 80 / 100 / 120 H: 195 / 214 / 233 / 243 / 253 / 272 total depth incl. front: 66.2 / 70.1 Effective depth: Shelf 54.0 / Clothes bar 61.4	Possible cabinet widths W: 160 / 180 / 200 / 240 / 280 / 300 / 320 / 360 / 400  Dimensions in cm

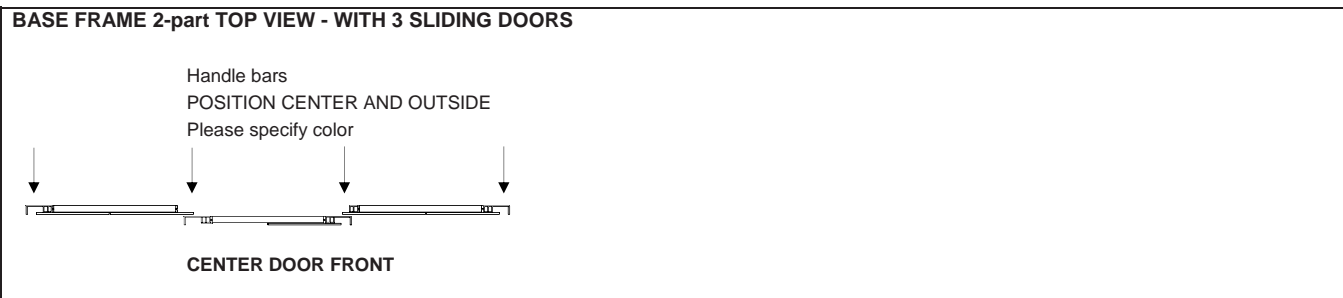
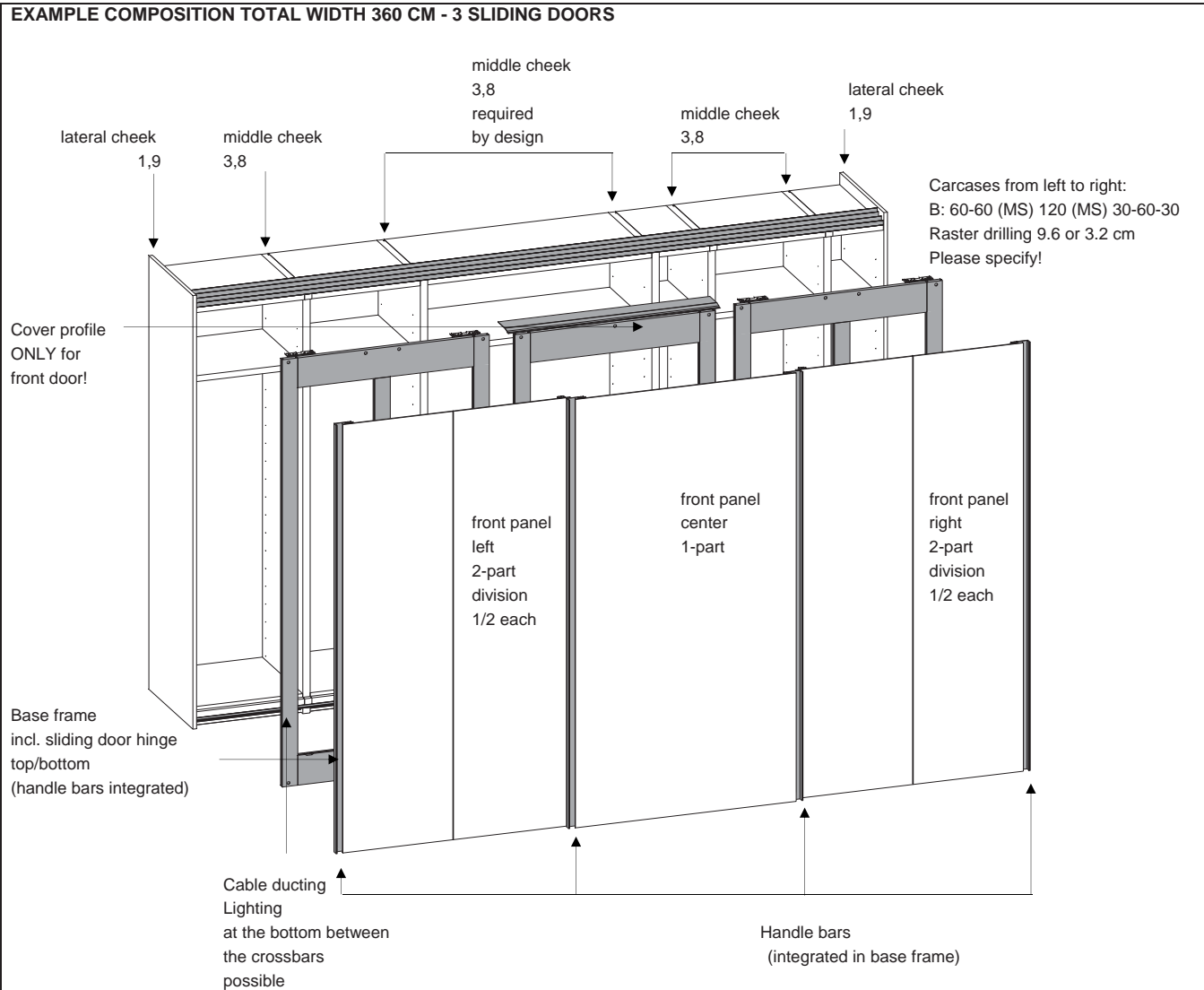

- PLANNING INFORMATION:**
- required height for installation +4.0 cm
  - required width for installation: +4.0 cm
  - lining left/right possible; not possible at top!
  - Wall mounting (anti-tilt) backside left and right through rear wall required. Fitting included.
  - room divider not possible!
  - Shortening in T/H possible! See special requests.

FRONT PANEL ARRANGEMENT  Dimensions in cm	BASE FRAME			FRONT PANELS					
	Wardrobe Total width	left sliding door	right sliding door	LEFT			RIGHT		
				1-PART	2-PARTS	3-PARTS	1-PART	2-PARTS	3-PARTS

**BASE FRAME**  
incl. sliding door fittings

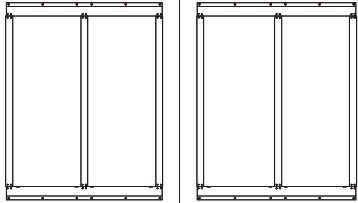

160	80	80							
180	90	90							
200	100	100							
240	120	120							
280	140	140							
300	150	150							
320	160	160							
360	180	180							
400	200	200							

**1-PART**

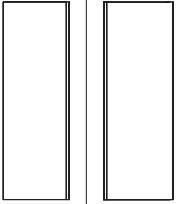

160	80	80	80		80			
180	90	90	90		90			
200	100	100	100		100			
240	120	120	120		120			

**2-PARTS**

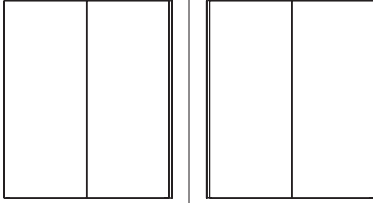

200	100	100		2x 50		2x 50		
240	120	120		2x 60		2x 60		
280	140	140		2x 70		2x 70		
300	150	150		2x 75		2x 75		
320	160	160		2x 80		2x 80		
360	180	180		2x 90		2x 90		
400	200	200		2x 100		2x 100		

**3-PARTS**

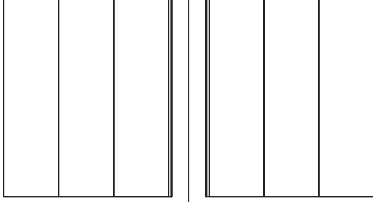

300	150	150		3x 50		3x 50		
320	160	160		3x 60*		3x 60*		
360	180	180		3x 60		3x 60		
400	200	200		3x 70*		3x 70*		

**PLANNING INFORMATION:**  
 - Front panels 3-parts in widths 320 and 400:  
 \* Front panels in the next larger width dimension are required. These are shortened accordingly.

INTERIOR FOR WARDROBE

W: 40 / 50 / 60 / 70 / 75 / 80 / 90 / 100 / 120

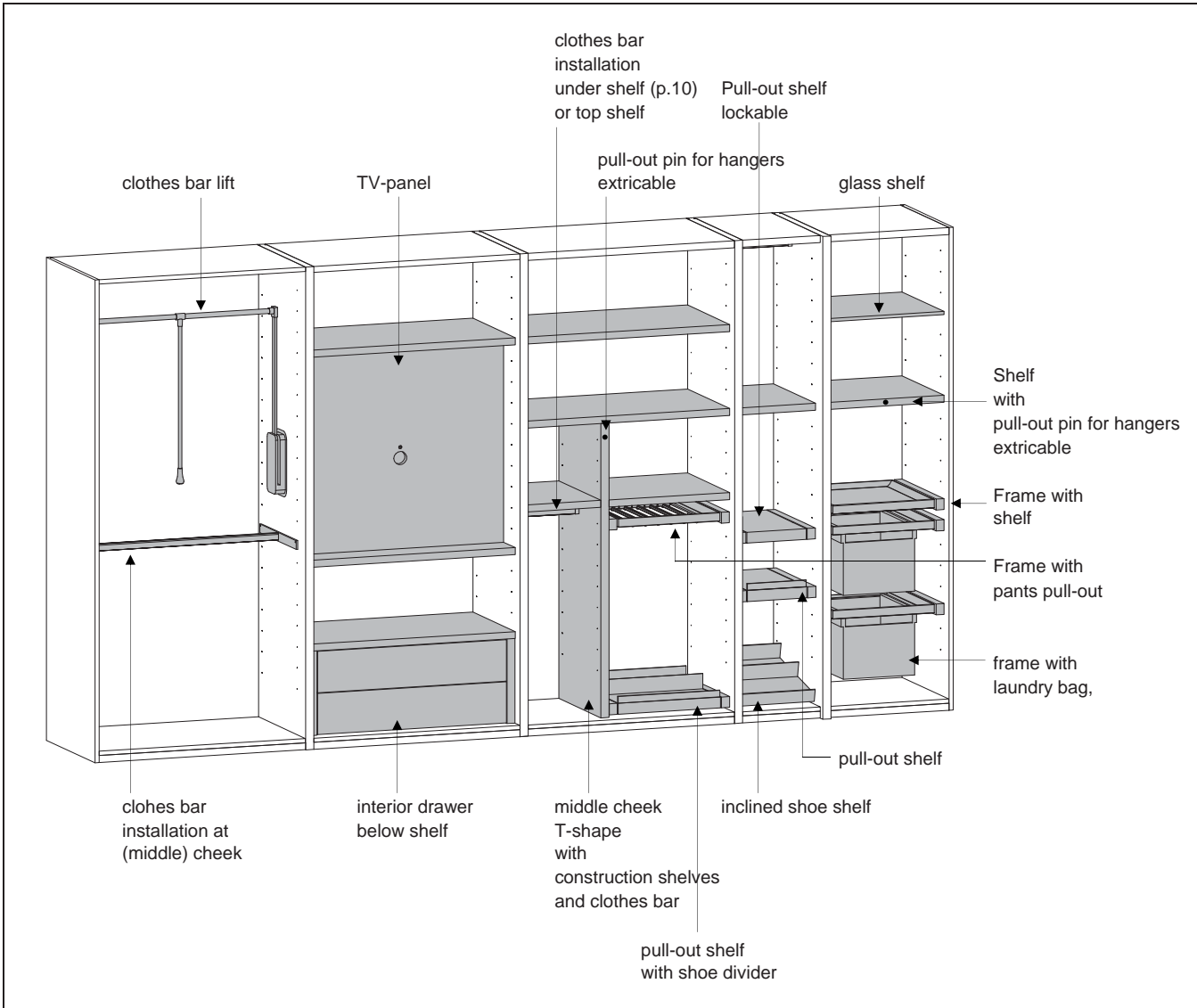

**PLANNING INFORMATION:**

- Interior partitions in widths 75 and 90 ONLY for FLAT and GRIP!

Recommended retail price  
Delivery/assembly excluded  
All previous lists are no longer  
valid.

Development and design  
Kettmaker-Team  
All models and names registered.  
All rights by Wolfgang Kettmaker.  
Kettmaker reserves the right to make subsequent  
changes, in particular if they serve the progress  
or mean an improvement.  
Errors excepted.  
Date 31.05.2024

Kettmaker GmbH & Co. KG  
Manufaktur für Möbel  
Bussenstraße 30  
88525 Dürmentingen  
Deutschland